







20 004 716

- hole diameter 32 mm
- rosette 60 x 47 mm
- with cold marking



Fits: CL.1, CYO

	Champagne (22kt Gold)	20 004 716-47
	Chrome	20 004 716-00
	Brushed Platinum	20 004 716-06
	Brushed Durabronze (23kt Gold)	20 004 716-28
	Brushed Champagne (22kt Gold)	20 004 716-46
	Brushed Dark Platinum	20 004 716-99

20 004 716

mm [inches]



Flow rate chart



Certificates

IAPMO_N-4976. LGA_28687. IAPMO_6397.

20 004 716

Parts for other finishes can be found here: [Chrome](#)

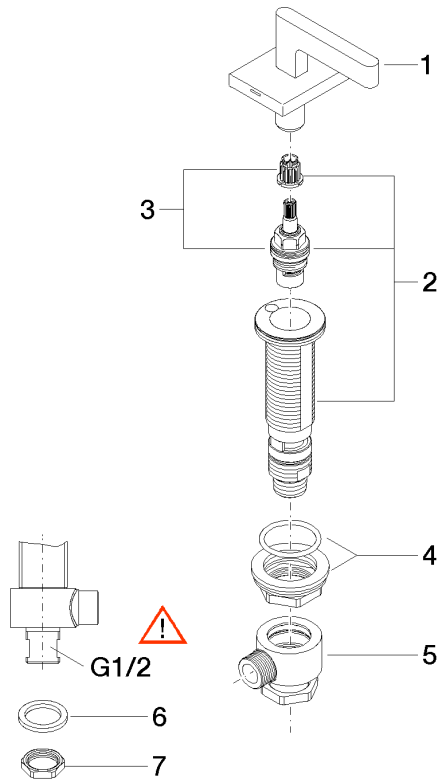

Spare parts list

No.	Item Number	Name	Quantity used	Delivery time
1	90 20 70 057 03-47	handle (cold)	1	30
2	04 17 11 058 52 90	side panel	1	2
3	90 90 03 152 00 90	top	1	2
4	04 23 10 032 78 90	fixing set	1	2
5	04 17 11 023 10 90	distributor	1	2
6	09 30 11 059 90	disc	1	2
7	09 23 10 012 90	nut	1	2